

Roof Bows 3-1

 Stoughton..... 3-1

 Dorsey..... 3-2

 Fruehauf..... 3-2

 Great Dane 3-3

 Hyundai..... 3-5

 Lufkin 3-6

 Manac 3-6

 Monon 3-6

 Pines 3-7

 Strick 3-7

 Trailmobile..... 3-8

 Utility 3-8

 Wabash 3-9

Roof Bow Fasteners..... 3-10

 Stoughton..... 3-10

Roofs 3-11

 Stoughton..... 3-11

ROOF BOWS Stoughton

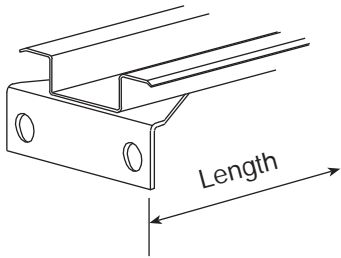

Stoughton Number	Length	Material
04 20019 002 00	92 3/4"	Steel
23 06636 000 00*	98 3/4"	Steel
23 04006 000 00	98 1/4"	Steel
* 23 04006 001 00	99 1/4"	Steel
23 03117 000 00	98 3/4"	Aluminum

*

* Skid quantity is 198 pieces

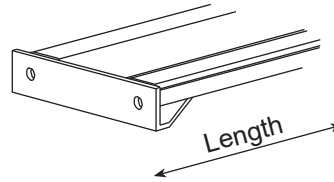

Stoughton Number	Length	Material	Remarks
04 20020 001 00	98 3/4"	Steel*	No holes in end clips
04 22599 001 00	98 3/16"	Steel	ZG Only
* 23 04039 000 00	98 3/16"	Aluminum	J.B. Hunt Only

*

* Replaces 23 08465 000 00

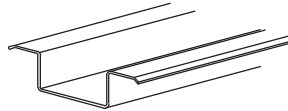

ROOF BOW

Stoughton Number	Length	Material
* 04 10207 000 00	97 15/16"	Steel
* 04 10207 002 00	99 5/16"	Steel
04 07660	98 3/4"	Steel

*

*

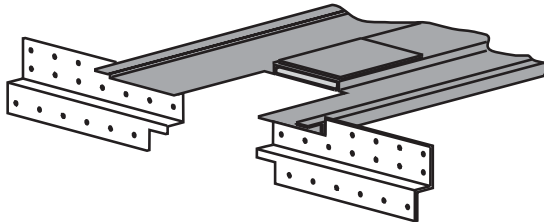

NOTE: Intermediate Header Assemblies at Stacking Post, see Section 15

* Refers to Container

ROOF BOWS

Dorsey

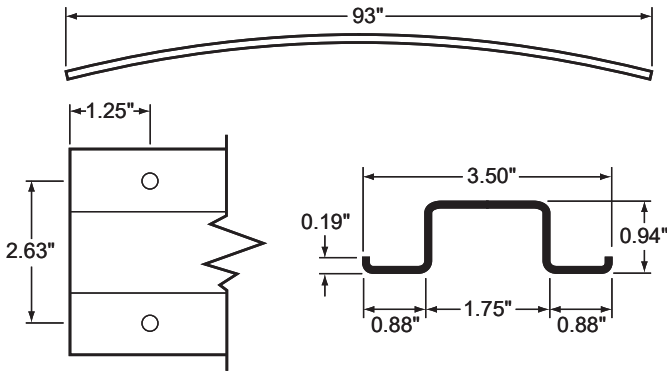

ROOF BOW, CAMBERED W/HOLES, 93"

Stoughton Number
DOR-1207863092

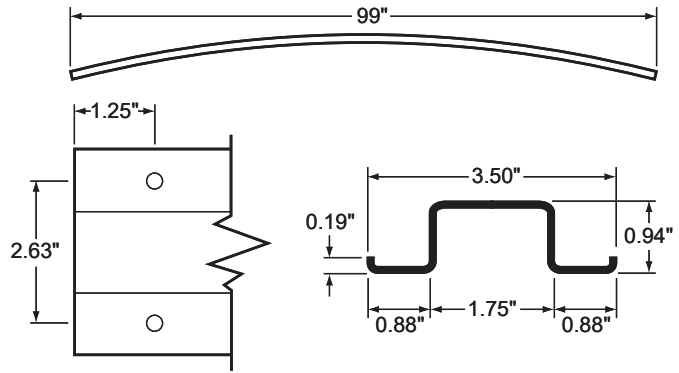

ROOF BOW, DORSEY STYLE, 99"

Stoughton Number
DOR-1208898099

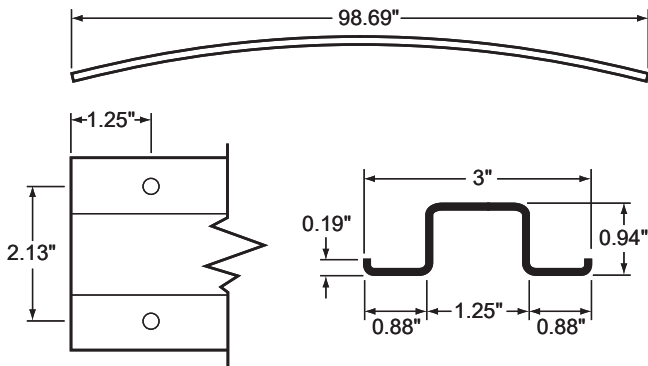

ROOF BOW, HAT STYLE, 98-11/16"

Stoughton Number
DOR-1209108

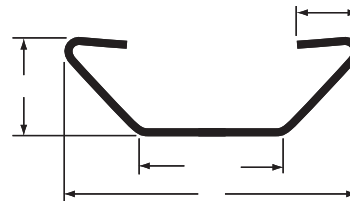

ROOF BOW, 16 GA, 98-5/8"

Stoughton Number
DOR-121069907

Fruehauf

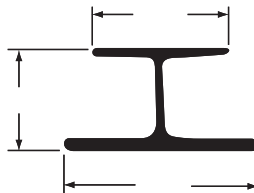

ROOF BOW, CAMBERED, ALUM, 98.5"

Stoughton Number
FRU#RCC-8431-3

ROOF BOWS Fruehauf

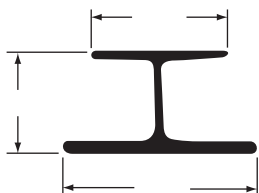

ROOF BOW, CAMBERED, ALUM, 92.75"

Stoughton Number
FRU#RCE-0169-1

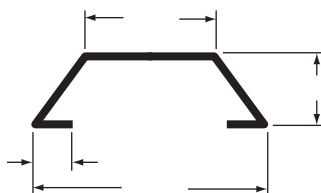

ROOF BOW, ANTI-SNAG, ALUM, 98.5"

Stoughton Number
FRU#RCF-3718-1

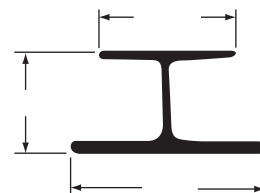

ROOF BOW, CAMBERED, ALUM, 98.5"

Stoughton Number
FRU#RCF-4048-1

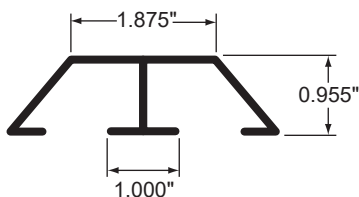

ROOF BOW, ANTI-SNAG, ALUM, 98.5"

Stoughton Number
FRU#RCF-4335-4

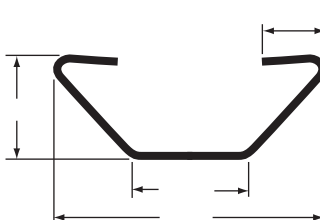

ROOF BOW, CAMBERED, ALUM, 91-1/8"

Stoughton Number
FRU#RCF-8426-1

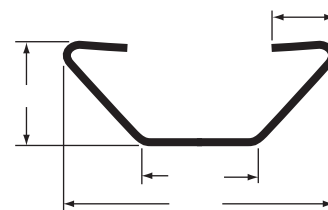

ROOF BOW, CAMBERED, ALUM, 97 1/8"

Stoughton Number
FRU#RCF-8426-2

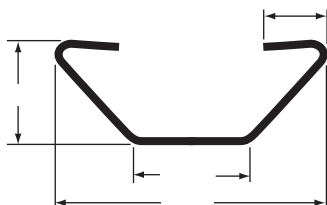

ROOF BOW, ANTI-SNAG, ALUM, 99"

Stoughton Number
FRU#RCF-8426-3

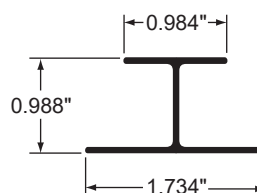

ROOF BOW, I-BEAM

Stoughton Number
FRU#STK20511

Great Dane

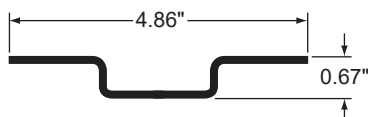

ROOF BOW, ALUM 92.25",

Stoughton Number
GD#08581



ROOF BOW, ALUM, 98-39/64"

Stoughton Number
GD#14113

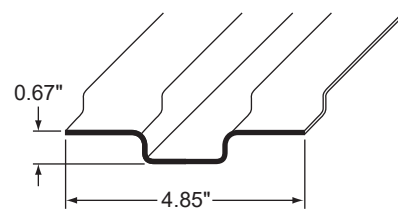

ROOF BOW, CAMBERED, GALV, 98.61"

Stoughton Number
GD#18380

ROOF BOWS

Great Dane

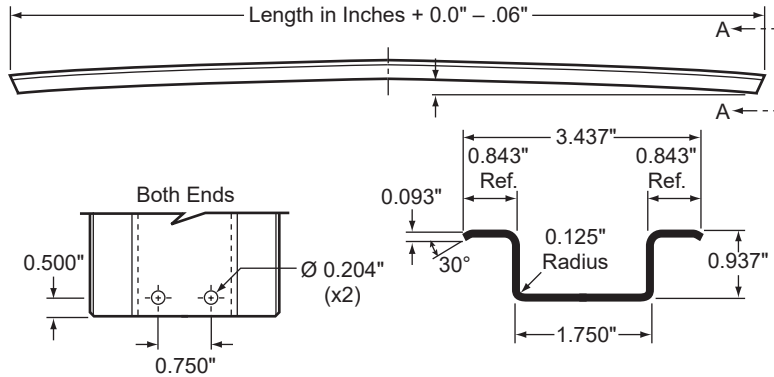

3/4" ROOF BOW, CAMBERED, 98.15"

Stoughton Number
GD#41203002



ROOF BOW, ALUM, 98.16"

Stoughton Number
GD#41203006

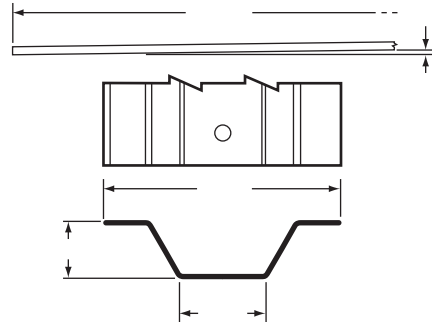

ROOF BOW, STEEL, 91.8"

Stoughton Number
GD#41203008

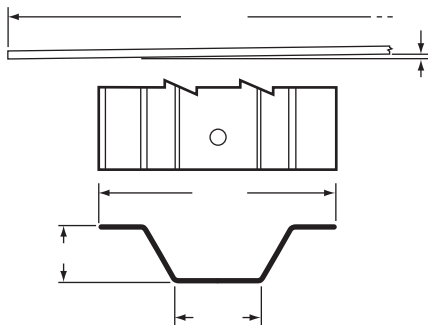

3/4" ROOF BOW, ARCH, STEEL 98.62"

Stoughton Number
GD#69102526

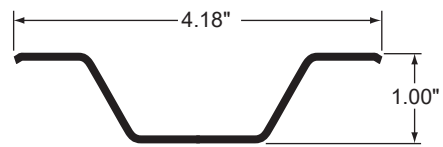

1/4" ROOF BOW, CAMBERED, 98.63"

Stoughton Number
GD#69201602

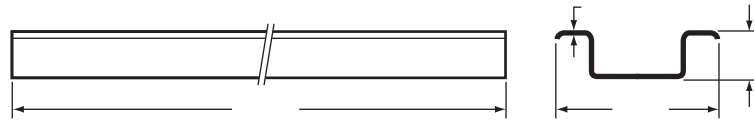

ROOF BOW, 3.45" W, 99.9"

Stoughton Number
HY#1000-2725

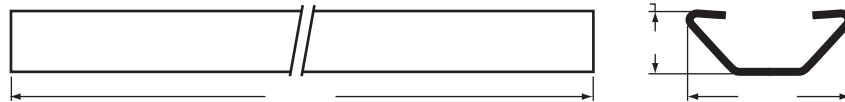

ROOF BOW, ANTI-SNAG, 18 GA, 99.10"

Stoughton Number
HY#1000-3944

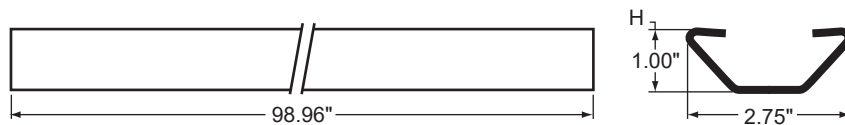

ROOF BOW, ANTI-SNAG, 18 GA, 98.86"

Stoughton Number
HY#1000-3953

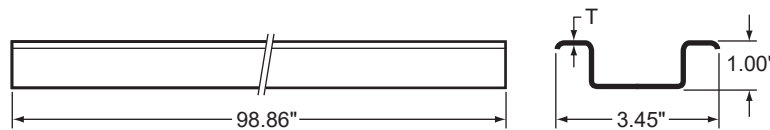

ROOF BOW, 3.45" W, 98.86"

Stoughton Number
HY#1000-6251

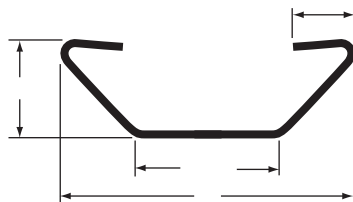

ROOF BOW, ANTI-SNAG, STEEL, 99"

Stoughton Number
HY#2000-2799

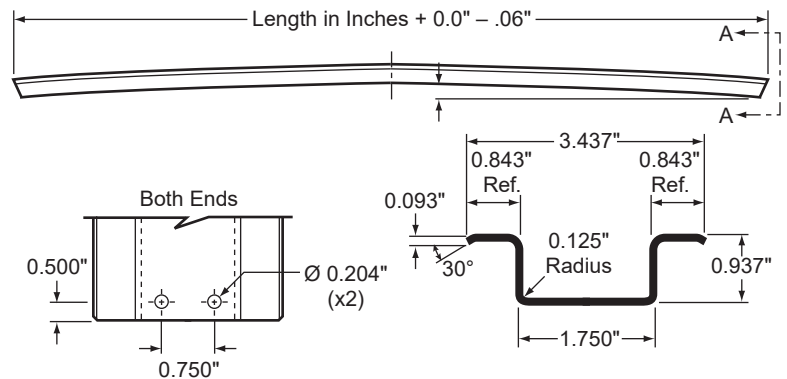

ROOF BOW, FLAT, W/HOLES, 99"

Stoughton Number
HY#9000-2801

ROOF BOWS

Lufkin

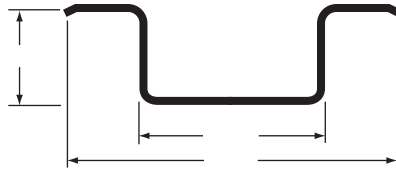

3.44" ROOF BOW, HAT STYLE, 98.88"

Stoughton Number
LUF-E7072822

Manac

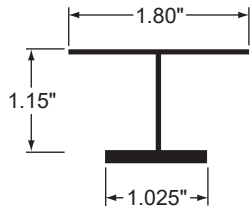

ROOF BOW, I-BEAM, 98.25" LONG

Stoughton Number
MANAC#502-407C



ROOF BOW, ANTI SNAG, 98.25" LONG

Stoughton Number
MANAC#502-420

Monon

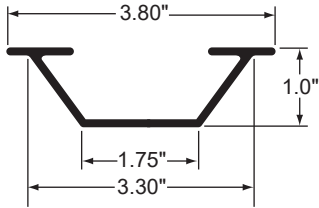

ROOF BOW, ANTI SNAG, ALUM, 99"

Stoughton Number
MON-AI015486

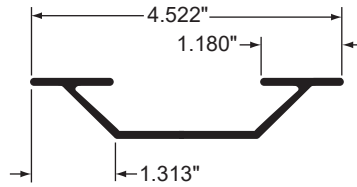

ROOF BOW, CONTAINER

Stoughton Number
MON-AX040364

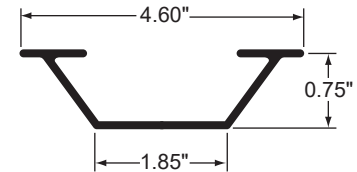

Aluminum MONON for Plate Container

ROOF BOW, ANTI-SNAG, 99"

Stoughton Number
MON-AX042110-099

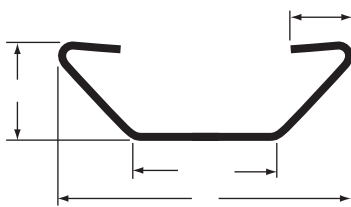

ROOF BOW, ANTI-SNAG, 99"

Stoughton Number
MON-V01-107

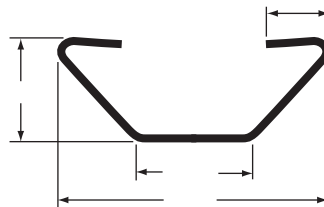

99" ROOF BOW

Stoughton Number
MON-V07-109E

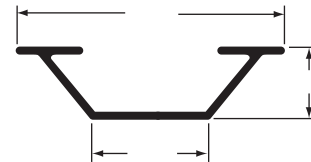

ROOF BOW, ALUM, 99"

Stoughton Number
MON-V07-118-B

ROOF BOWS Pines

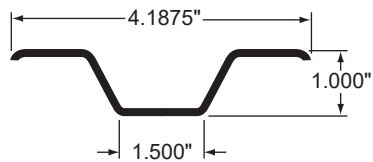

ROOF BOW, STEEL HAT, 99.25"

Stoughton Number
PINE RC14300

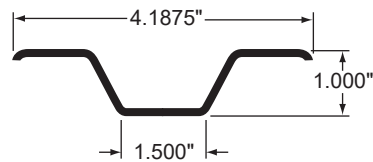

ROOF BOW, 99.125" W, 9/32" DIA HOLE

Stoughton Number
PINE RCB-2629

Strick

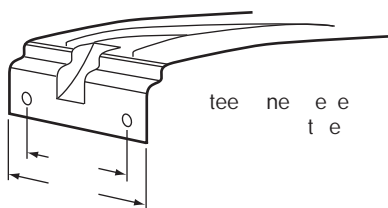

ROOF BOW, STD ARCH, GALV, 92.75"

Stoughton Number
STRAA39C000201

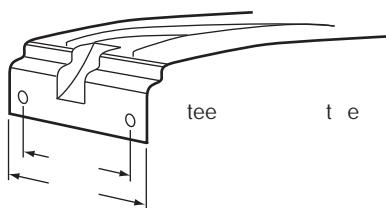

ROOF BOW, STD ARCH, GALV, 98.88"

Stoughton Number
STRAA39C00120100
STR#27820

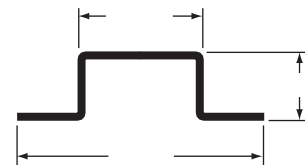

ROOF BOW, 98.5" L

Stoughton Number
STRAA82C000908E5

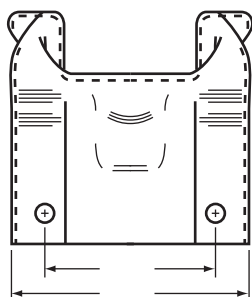

ROOF BOW, HIGH ARCH, GALV, 98.88"

Stoughton Number
STRAA39C00210100
STR#01510

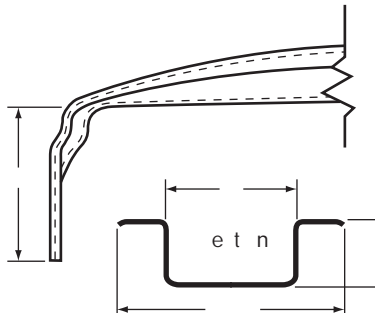

ROOF BOW, HIGH ARCH, GALV, 100.38"

Stoughton Number
STRAA39C00210400
STR#01512

ROOF BOW, HIGH ARCH, GALV, 92.94"

Stoughton Number
STRAA39C00210200
STR#01511

ROOF BOW, HIGH ARCH, GALV, 99.44"

Stoughton Number
STRAA39C00210500
STR#01513

ROOF BOW, HIGH ARCH, GALV, 99.13"

Stoughton Number
STRAA39C00210300
STR#48533

ROOF BOWS

Trailmobile

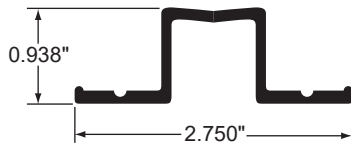

ROOF BOW, HAT, ALUM, 99.125"

Stoughton Number
TM514-3-145-A-2

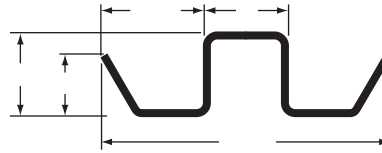

ROOF BOW, 16 GA STEEL, 99.125" L

Stoughton Number
TM514-3-152B

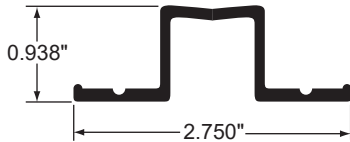

ROOF BOW, 100" LONG

Stoughton Number
TM90-4-1801-0100

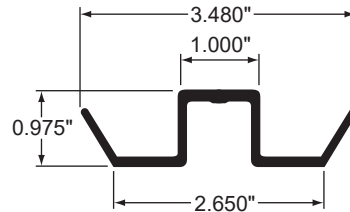

ROOF BOW, CAMBERED, ALUM, 99.125"

Stoughton Number
TM90-4-1718-0-99

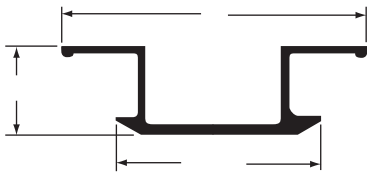

ROOF BOW, TRAILMOBILE, ALUM, 93.5"

Stoughton Number
TM90-4-703-0-93

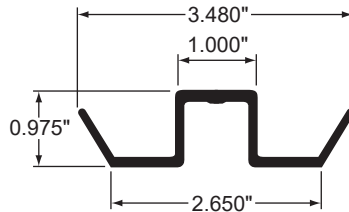

ROOF BOW, CAMBERED, ALUM, 99.125"

Stoughton Number
TM9514-3-11-2

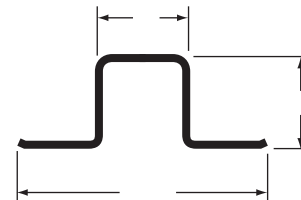

ROOF BOW, 16 GA STEEL, 99.125" L

Stoughton Number
TM9514-3-78B

Utility

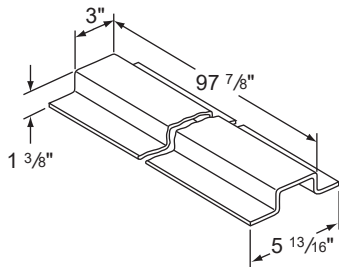

ROOF BOW, GALV, 14 GA, 99.5" L

Stoughton Number
UT-03-1600-0-040

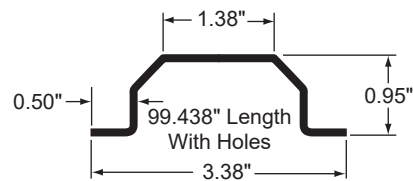

Utility Steel Cambered Roof Bow

ROOF BOW, CAMBERED, STEEL, 99.38"

Stoughton Number
UT-03-1600-0-053
UT-03-1600-0-054

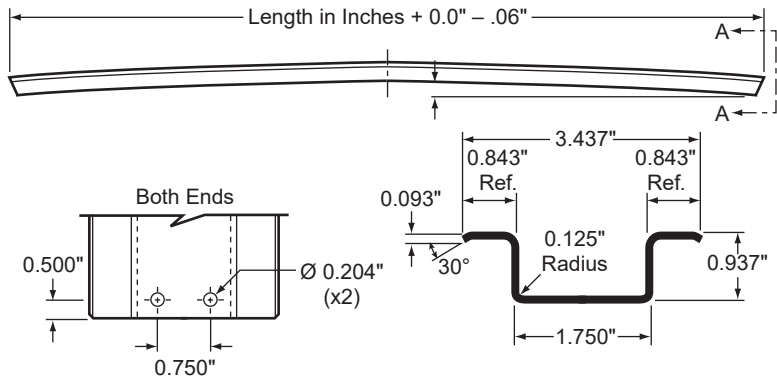

ROOF BOW, WABASH STYLE, FLAT, 99"

Stoughton Number
WAB-03011215

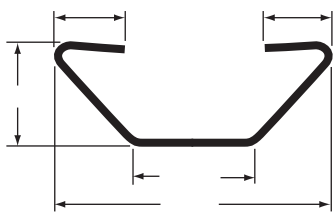

ROOF BOW, ANTI-SNAG, 99.375"

Stoughton Number
WAB-07200003

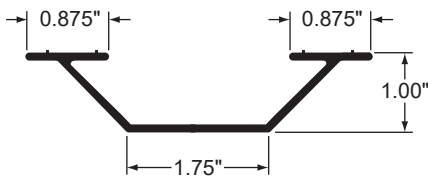

Aluminum Anti-Snag Cambered

ROOF BOW, ANTI-SNAG, STEEL, 99"

Stoughton Number
WAB-07200005

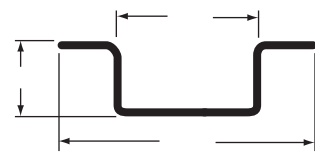

HAT STYLE ROOF BOW, 16 GA, 99"

Stoughton Number
WAB-07200012

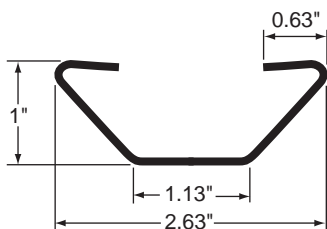

ROOF BOW, ANTI-SNAG, STEEL, 99"

Stoughton Number
WAB-07200028

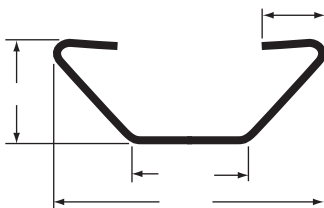

1" ROOF BOW, 18 GA, 80GR, 98.75"

Stoughton Number
WAB-07200033

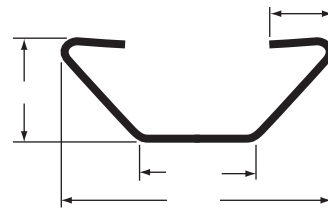

ROOF BOW, 18 GA GALV STEEL, 93.75"

Stoughton Number
WAB-07200040

ROOF BOWS

Wabash

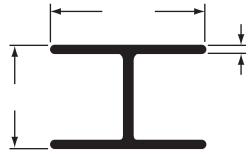

ROOF BOW, CAMBERED, 99"

Stoughton Number
WAB-07200043

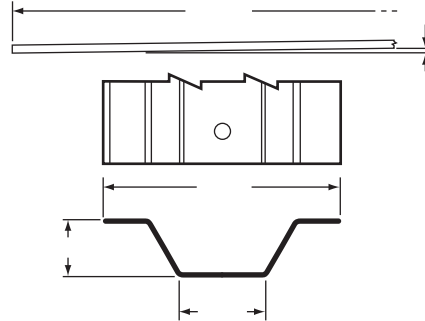

ROOF BOW, STEEL, 99.125"

Stoughton Number
WAB-07200074

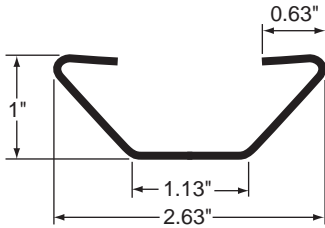

ROOF BOW, ANTI-SNAG, STEEL, 93"

Stoughton Number
WAB-07200079

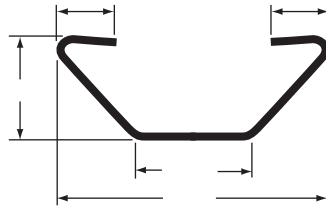

2.675" ROOF BOW, 18 GA, 96"

Stoughton Number
WAB-07200106

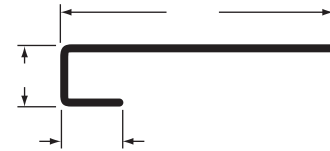

J-MOLDING, EXTRU ALUM, 120"

Stoughton Number
WAB-E0821200

ROOF BOW FASTENERS

Stoughton

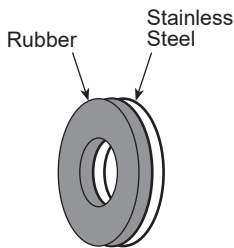

RUBBER/STEEL
WASHER - 5/16"

Stoughton Number	Remarks
04 96031 000 00	
04 96042 000 00	Z-Plate

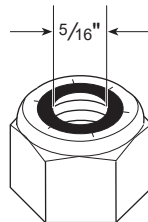

NYLON
LOCK NUT - 5/16"

Stoughton Number	Remarks
04 95536 000 00	
04 95549 000 00	Z-Plate

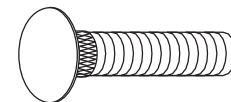

CARRIAGE BOLT

Stoughton Number	Remarks
04 95029 100 00	5/16" -18 x 1"
04 95075 100 00	Z-Plate

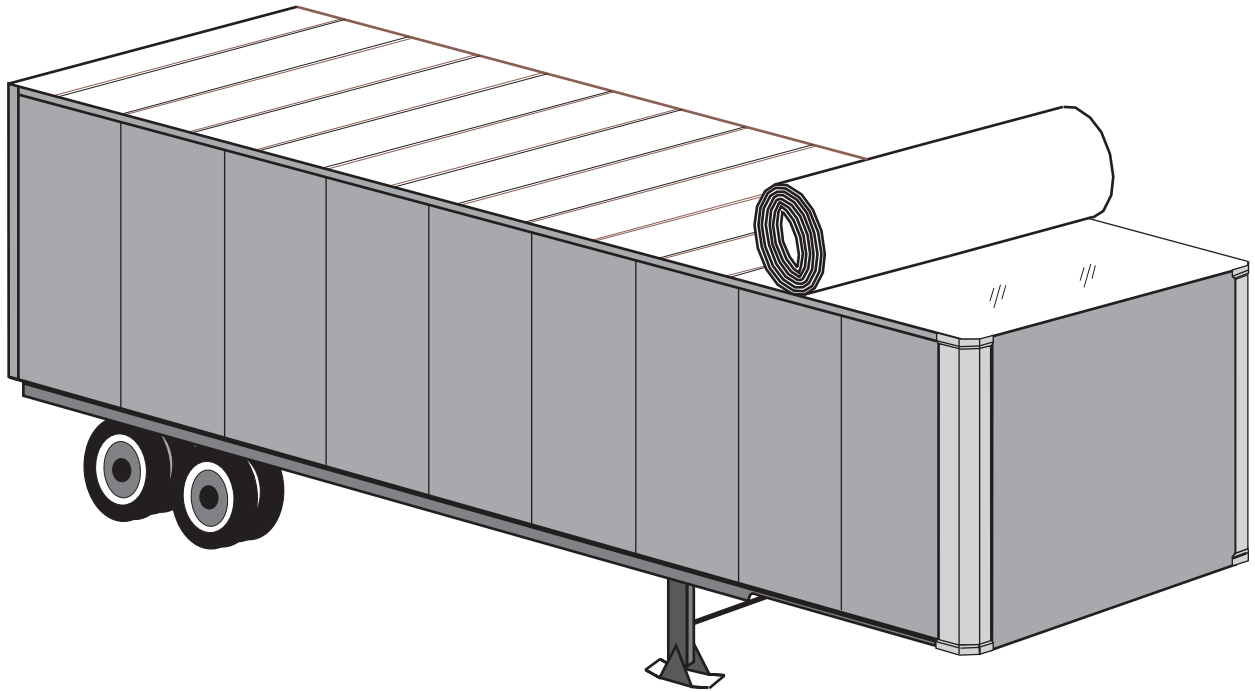

MASTER COILS

Stoughton Number	Width	Material
00 15040 103 00	103"	.040 Aluminum
LASCO Roof 103W	103"	.075 Translucent

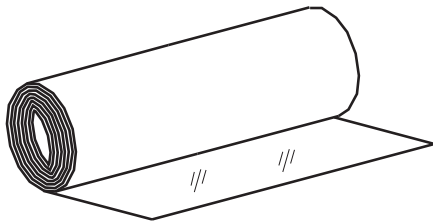

SPECIFIC LENGTHS

Stoughton Number	Width	Material	Length
01 07018 027 03	103"	.040 Aluminum	28'
01 07018 030 03	103"	.040 Aluminum	31'
01 07018 040 03	103"	.040 Aluminum	41'
01 07018 045 03	103"	.040 Aluminum	46'
01 07018 048 03	103"	.040 Aluminum	49'
01 07018 053 03	103"	.040 Aluminum	54'
01 07018 100 03	103"	.040 Aluminum	100'
00 15040 103 12	103"	.040 Aluminum	By the Foot
CKBES2508T1WX30	102"	.075 Translucent	30' for 28' Trailer
CKBES2508T1WX48+	102"	.075 Translucent	49' for 48' Trailer
CKBES2508T1WX53+	102"	.075 Translucent	54' for 53' Trailer
CKETR 102X53	102"	"ETR" Translucent	54' for 53' Trailer

ALUMINUM COIL "END CUTS"

Stoughton Number	Width	Material	Length
00 15040 102 12	102"	.040 Aluminum	Sold by the Linear Foot "Great Patch Material"

Note: This is production scrap. Call for availability.

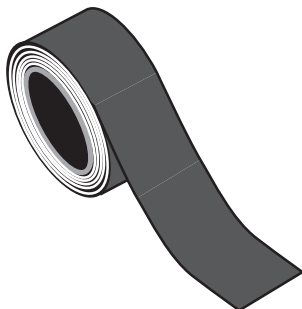

ROOF BOW TAPE

Stoughton Number	Length
04 85016 000 XX MP1858	Foam Tape 3/4" x 100' "Grip Tape" 1/8" x 5/8" x 65' Roll – 16 Per Case

ROOF EDGE SEALER TAPE

Stoughton Number	Length
04 85017 000 XX	Black Sealer Tape 1" x 50'

ROOFS Stoughton

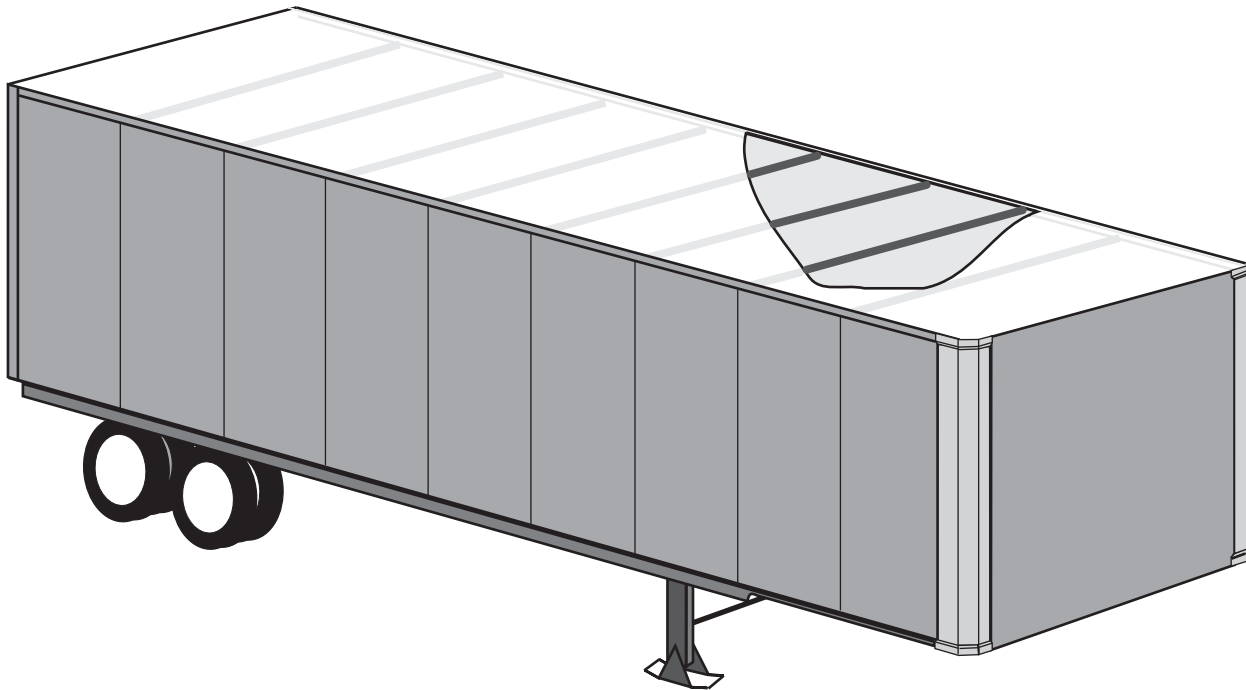

Note: Special lengths are available – CALL FOR QUOTE



Stoughton Number
CKTFIX

Contents (enough for six square feet, 3-ply repair)	
1	Quart of T-Mix
1	Tube of catalyst (1/2 oz)
1	18 sq. ft. piece of chopped strand mat
1	3' by 4' piece of embossed film
1	3' by 4' piece of smooth film
2	Mixing cups (1 pint)
2	Squeegees
2	Mixing sticks
1	Pair of gloves

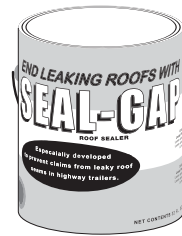

SEAL-GAP ROOF SEALANT

Stoughton Number	Remarks
SEAL GAP	Sold per Gallon

SUNPATCH KIT

Stoughton Number	Remarks
CKR50 SNPTCHKIT	Roof Repair Kit – 1 sq. ft. (12" x 12")

ROOF BOW ADHESIVE

Stoughton Number
MP75-AMGRAY

ALUMINUM ROOF SEALER

Stoughton Number	Remarks
MP65-H ALUM	Sold per Gallon

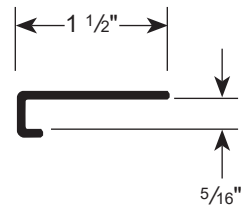

ROOF EDGE TRIM

Stoughton Number	Remarks	Length
02 11426 216 00	For Translucent Roofs – OE Style	18'
WAB-E0821200	Aftermarket Style	10'